

ECLIPSE AUTO OPERATION HAND DRYER OPERATING MANUAL

ML_ECLIPSE01_WHT

ML_ECLIPSE05_SS

ML_ECLIPSE_DESIGNER



Operating Instructions and Parts Manual (Automatic)

Surface Mount

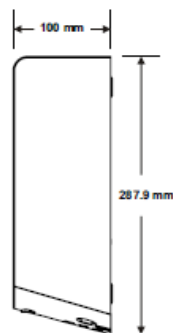
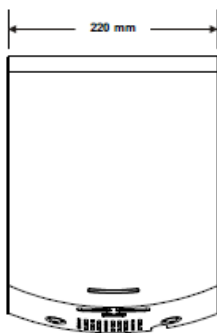

This unit is accessible compliant when installed in accordance with AS1428.1. guidelines.



TECHNICAL SPECIFICATIONS

ITEM CATEGORY	PERFORMANCE DATA
Operating Voltage	220-240Vac, 50/60Hz, 1.0kW
Warm Air Speed Output	95-115m/s, adjustable
Motor Type	500W, 16,000-29,000r.p.m., Adjustable; Brush Type, Dual Ball Bearings
Motor Thermal Protection	Auto Resetting Thermostat turns unit off at 95°C {203°F}
Heater Element	325-500W, adjustable
Heater Thermal Protection	Auto Resetting Thermostat turns unit off at 85°C {185°F}
Drying Time	Less than 15 seconds
Stand-by Power	Less than 0.5W
Circuit Operation	Infrared Automatic, self adjusting
Sensor Range	Standard [170 ± 20mm], Adjustable, The range is [100 - 230mm]
Timing Protection	60 seconds auto shut off
Drip proof	IP24
Isolation	CLASS 1
Net Weight	4.2kg
Shipping Weight	4.8kg
Unit Size	220mm (W) x 287.9mm(H) x 100mm (D)

The photographs and line drawings of the products presented above are representational only. Metlam Australia Pty Ltd reserves the right to, and from time to time, make changes and improvements in design and dimensions.

Cover Type/ Cover Finish

ML_ECLIPSE01_WHT: 1.2mm White Powder Coat Steel

ML_ECLIPSE05_SS: 1.2mm #304 Satin Stainless Steel

ML_ECLIPSE05_DESIGNER: 1.2mm Designer Matte Black Powder Coat Steel

Recommended mounting heights

- from bottom edge of dryer above finished floor (AFF) -

Men	50"	(1270mm)
Women	47"	(1194mm)
Children 4-7 years	35"	(889mm)
Children 8-10 years	39"	(991mm)
Children 11-13 years	43"	(1092mm)
Children 14-16 years	47"	(1194mm)

Accessible Compliant:

Where provided, hand dryers shall be installed with the height of their operative component or outlet not less than 900mm and not more than 1100mm above the plane of the finished floor, and no closer than 500mm from an internal corner. Refer: AS1428.1-2009, Clause 15.4.3

Operation

- Shake excess water from hands.
- Place hands under the nozzle and dryer automatically starts operation.
- Rub hands lightly and rapidly under the nozzle.
- Dryer stops when hands are removed from sensor zone or if maximum time is reached.

Cleaning and Maintenance

Periodic cleaning of the unit is recommended to ensure optimum performance.

- Disconnect the electrical supply.
- Remove the two cover-mounting screws.
- Remove the cover.
- Clean all dust lint from the interior of the dryer.
- Wipe the cover with a damp cloth and mild cleaning solution. Do not Soak. Never use abrasives to clean the cover.
- Replace the cover. Do not over tighten the screws.

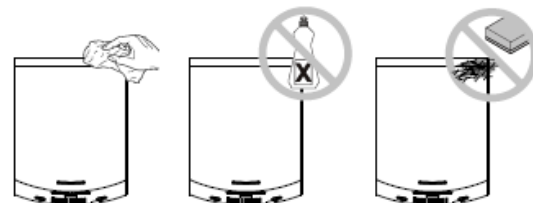

The photographs and line drawings of the products presented above are representational only. Metlam Australia Pty Ltd reserves the right to, and from time to time, make changes and improvements in design and dimensions.

Warm air speed adjustment

1. Switch off the power, loosen the cover screws and remove the cover.
2. Use small Philips head screwdriver or plastic flat blade Probe to turn VR shaft. Clock-wise [CW] to increase power to maximum (+) ↻, turn tool gently [CCW] to reduce power as required (-) ↻.

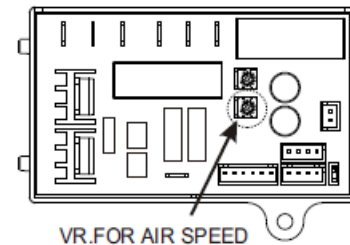

Heater Element Switch ON/ OFF

1. Switch off the power, loosen the cover screws and remove the cover.
2. Adjust the heater switch on the PCB with a small plastic or wood flat blade probe.
 - 2-1. Slide the switch to "ON" :Enables heater on.
 - 2-2. Slide the switch to "1" :Disables heater.

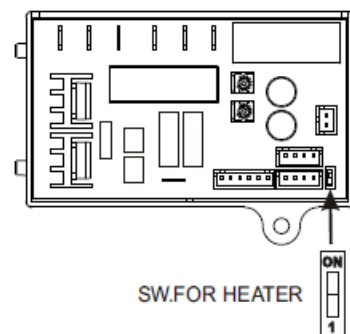

Sensor range adjustment

1. The range is 4" to 9" [100mm to 230mm], standard setting is 7" [170mm ± 20mm]
2. Clockwise: Increases the sensing range(+) ↻
3. Counterclockwise: Decreases the sensing range(-) ↻
4. **DO NOT OVERTURN!**

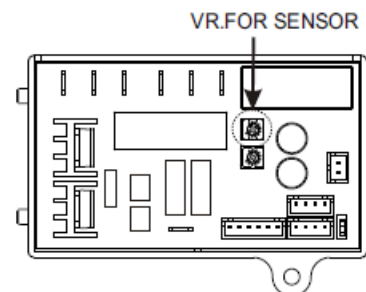

The photographs and line drawings of the products presented above are representational only. Metlam Australia Pty Ltd reserves the right to, and from time to time, make changes and improvements in design and dimensions.

Diagnostics and Remedies

Symptom	Corrective Actions for Initial Installation Failures
If the dryer will not run	First ensure that the breaker supplying the dryer is operational. If it is, disconnect the power and remove the dryer cover. Taking suitable precautions to avoid shock hazard, reconnect the power and check for Voltage at the terminal block. Verify that connections are made correctly.
The dryer cycles by itself or runs constantly	Ensure that there is no obstruction on or in front of the IR sensor. Clean any dirt or debris off the sensor lens. If problem persists, replace sensor.
The dryer makes a loud noise and does not run for a complete cycle	Ensure that the supply Voltage is correct. Dryer will make a loud humming noise if the input Voltage is too high. Verify Voltage requirement on unit rating label and correct supply as required. If CBM has been damaged, replace CBM, IR sensor module.
The dryer runs but air stream is low pressure and/or low velocity	Ensure that the supply Voltage is correct. Dryer will run weakly if the input Voltage is too low. Verify Voltage requirement on unit rating label and correct supply as required.
Symptom	Corrective Actions for In-Service Failures
If the dryer will not run	First ensure that the breaker supplying the dryer is operational. If it is, disconnect the power and remove the dryer cover. Replace the CBM and IR sensor module. Taking suitable precautions to avoid shock hazard, reconnect the power and check for Voltage at the terminal block.
The IR sensor only "sees" close range objects	Ensure that there is no obstruction on or in front of the IR sensor. Clean any dirt or debris off the sensor lens. If problem persists, disconnect the power and remove the dryer cover and replace CBM, IR sensor module.
The heater gets hot but no air stream is produced	Disconnect the power. Remove the dryer cover. Check VR for speed setting Disassemble the blower- motor/ fan housing. Replace the fan motor. Reassemble.
The dryer only blows cold air during a full cycle	Disconnect the power. Remove the dryer cover and check/ ensure heater SW is ON. Disassemble the blower-motor/fan housing. Test the thermostat for open circuit. Check the heater element for signs of burning or breakage. Damaged element must be replaced.
The air stream is low pressure and velocity	Check the output nozzle for obstructions. If none are present, disconnect the power. Remove the dryer cover. Remove any dust/lint buildup from intake vent slots. Check VR for speed setting. Disassemble the blower-motor/fan housing. Check the motor brushes for worn condition ($\leq 1-3/16"$ [30mm] graphite remains) and replace them, if necessary.

Important Information

This Product falls within the scope of the Waste Electrical & Electronic Equipment Directive 2002/96 EC. (WEEE)



NOTE:
 This Product should not be disposed of with household waste. Please recycle where facilities exist. Check with your local authority for recycling advice.

The photographs and line drawings of the products presented above are representational only. Metlam Australia Pty Ltd reserves the right to, and from time to time, make changes and improvements in design and dimensions.

Assembly Diagram

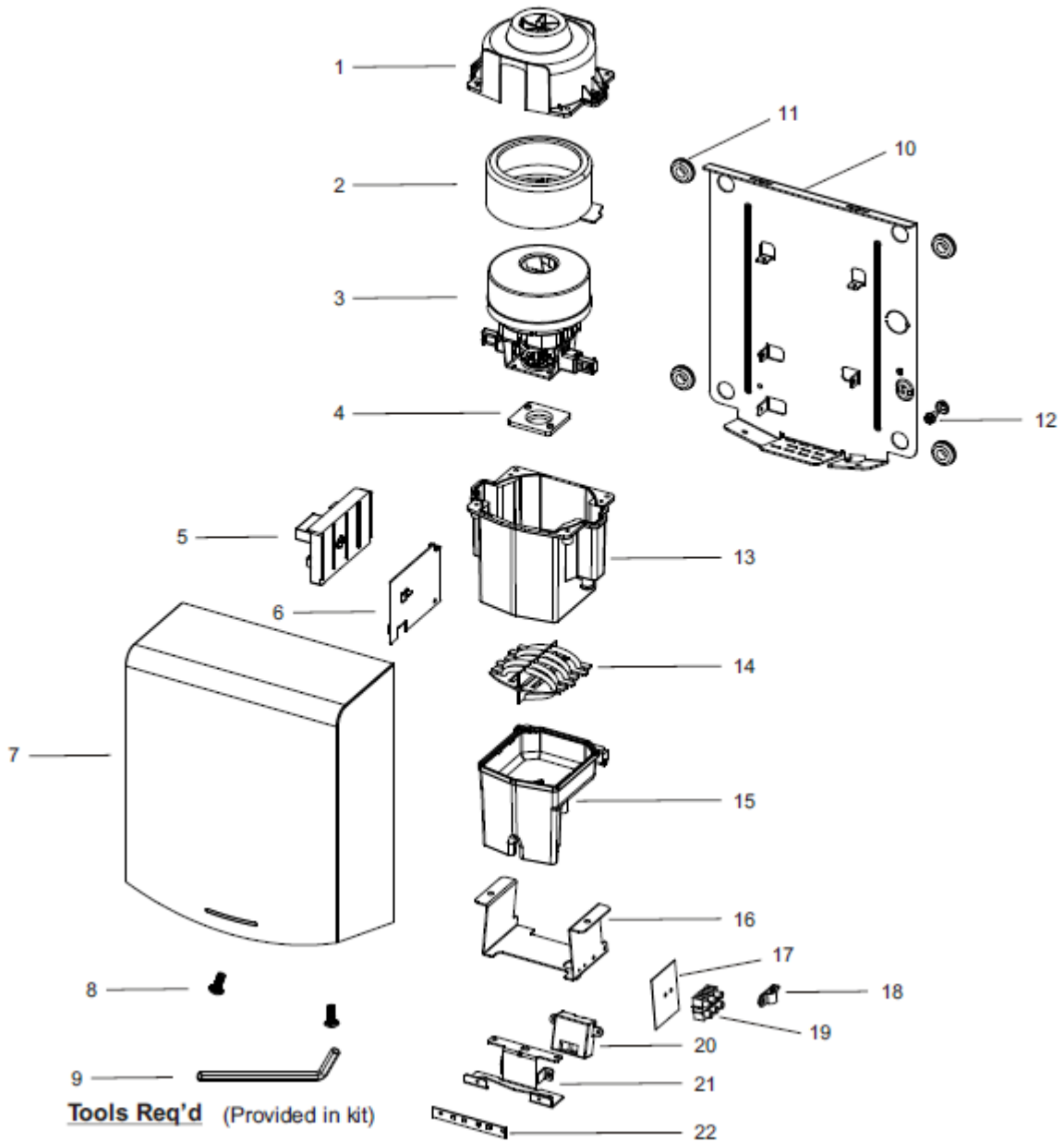

The photographs and line drawings of the products presented above are representational only. Metlam Australia Pty Ltd reserves the right to, and from time to time, make changes and improvements in design and dimensions.

Repair parts list

Key	Description
1	Blower housing - Upper
2	Motor rubber - Lower
3	Motor
4	Motor rubber - Upper
5	Circuit Board Module (CBM)
6	Circuit Board Module bracket
7	Cover
8	Security hex cap head 1/4"-20 x 5/8" screw with lock washer
9	L-Wrench
10	Base plate
11	Rubber grommet -Base
12	Grounding screw with cup washer
13	Blower housing - Lower
14	Heater assembly
15	Air outlet
16	Air outlet bracket
17	Mylar shield with LNG marked
18	Cable clamp
19	Terminal block
20	Sensor module
21	Sensor bracket
22	LED assembly

Warranty

The product warranty is 5 years (3 years Parts and Labour plus 2 years parts only) from the date of purchase. For more information, please see Metlam Australia's Warranty Statement: <https://www.metlam.com.au/service-support>

Service

For Service related enquiries please email: service@metlam.com.au

The technical recommendations contained in this document are necessarily of a general nature and should not be relied on for specific applications without first securing competent advice. Whilst Metlam Australia Pty Ltd has taken all reasonable steps to ensure the information contained herein is accurate and current, it does not warrant the accuracy or completeness of the information and does not accept liability for errors or omissions. Any Commercial product should only be installed by a competent tradesperson and serviced/maintained by knowledgeable janitorial staff or competent people. Metlam Australia accepts no responsibility for any damage to product, walls or fixtures due to incorrect installation or maintenance of any of their products.

The photographs and line drawings of the products presented above are representational only.
Metlam Australia Pty Ltd reserves the right to, and from time to time, make changes and improvements in design and dimensions.